

Thread locking and sealing

Insulating coating

TufLok[®]/Nytemp[®]
Nyseal[®]
Nystay[®]
Nyplas[®]
Nycote[®]
precote Top 300[®]
precote/3M

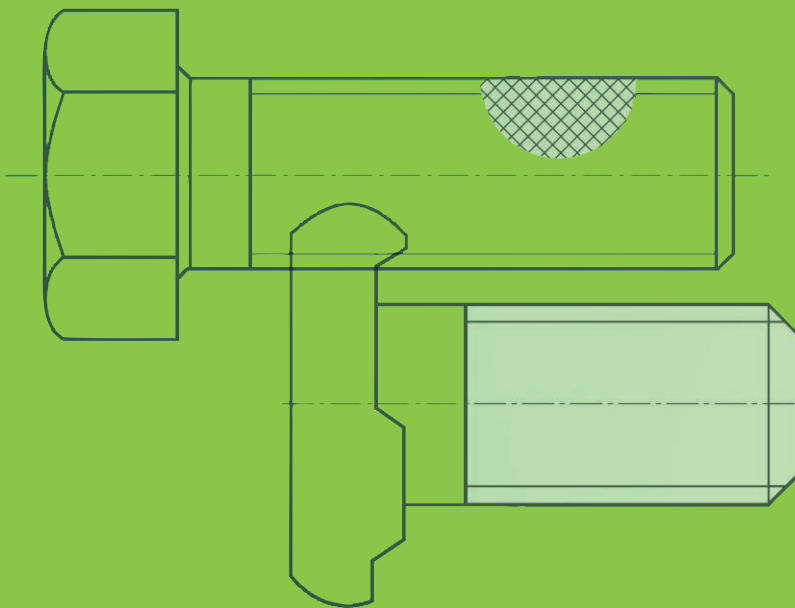

Technical publication

No.60

Kerb Konus





Fastening technology from KerbKonus is in successful application in a wide variety of different industrial sectors around the world.

State-of-the-art production facilities provide our customers with the assurance of quality and reliable delivery, and sophisticated fastening solutions for every conceivable field of application are implemented by our own Research and Development Department.

Close cooperation and exchange of experience and expertise on an international level ensure that our company stays at the cutting edge of technological development.

With independent branches and agencies operating in a number of countries around the world, we are a truly reliable partner when it comes to secure fastening technology you can rely on.

... our products and services

Alongside its renowned threaded inserts, the name KerbKonus also stands for comprehensive products and services in the field of connecting technology. KerbKonus offers its services as a reliable contract coater to prepare threads for a wide range of different requirements:

- Thread locking
- Thread sealing
- Insulating plastic coating

Threaded inserts from KerbKonus have been thoroughly tried and tested over the years and used in a wide variety of applications to create connections you can rely on. Depending on the method of anchoring in the material, KerbKonus offers a variety of different threaded insert versions:

- Self-tapping threaded inserts for metal, wood and plastics,
- Threaded inserts for cold embedding
- Threaded inserts for hot or ultrasound embedding
- Threaded inserts for screwing into an internal thread
- Threaded inserts for riveting

For the reliable, cost-effective connection of thin mouldings and parts made of aluminium and magnesium, KerbKonus offers the:

- Tuk-Rivet, the complete punched rivet system for thin mouldings

If you have a specific problem related to the field of fastening technology – with its rich fund of expertise and comprehensive product range, KerbKonus has the solution for you.

Technical details on KerbKonus products are also provided on our homepage: www.kerbkonus.de

To access design data, go to the download portal of our website. Here, you will be able to download product data in any required formats or as CAD files..

Kerb-Konus-Vertriebs-GmbH
Wernher-von-Braun-Straße 7
Gewerbegebiet Nord
92224 Amberg



Phone +49 9621 679-0
Fax +49 9621 679444
e-mail KKV-Amberg@kerbkonus.de

Internet www.kerbkonus.de

Thread coating ...

Dimensions Field of application Sealing method Specifications Further description

Thread coating from KerbKonus ...

Tested quality and reliability
Coatings in application and on the test stand

Page 2 and 3
Page 4 and 5



TufLok® „der blaue Fleck“® (the blue patch)

Screws:
M0,8 to M68
Nuts:
M5 to M20

Up to 120°C, short term up to 150°C, nylon spot coating, Colour: blue

360°-coating

Works Standard 900/945

Page 6 to 9



Nytemp®

Screws:
M0,8 bis M68
Nuts:
M5 to M12

Up to 200°C, plastic spot coating
Colour: orange

360°-coating

Works Standard 900/945

Page 6 to 9



Nyseal®

M3 to M20
ISO 4 to ISO 10

Colour: green or transparent

360°-plastic

Works Standard 903 2

Page 10 and 11



Nystay®

from Ø 3 mm

Colour: green, fixing, Polyolefin foam

Works Standard 903 4

Page 12 and 13



Nyplas®

Screws from M3

Colour: black
PVC/Plastisol-coating

360°-coating

Works Standard 903 3

Page 14 and 15



Nycote®

M5 to M16

Insulating coating

No

Works Standard 911/912/913

Page 16 to 19



precote 30/80/85

from M2

Up to 170°C, plastic adhesive in microcapsules
Colour: yellow, red, turquoise

360°-coating

Works Standard 924/926/927

Page 20 to 21



3M 2353/3M 2510

from M2

Short term up to 150°C - 3M 2510
plastic adhesive in microcapsules
Colour: blue, orange

360°-coating

Works Standard 924 to 929

Page 20 to 21



precote 5/15

from M2

Film-forming dispersion
Colour: white

360°-coating

Works Standard 924 to 927

Page 22 to 23



precote Top 300®/OKS 1765

Screws M3 to M20

antifriction
Colour: yellowish

360°-coating

Works Standard 930

Page 24 to 25



precote 709

Screws/bolts

up to 850°C

360°-coating

Works Standard 926...4/927...4

Page 26



precote 10-1

Screws/bolts

up to 100°C
150°C

360°-coating

Works Standard 926...1/927...1

Page 27

What really counts: tested quality.

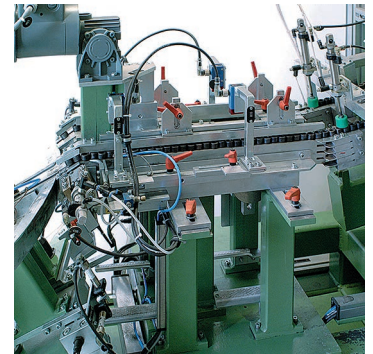

At our parent plant in Amberg, we produce threaded inserts using efficient production methods. A team of qualified and highly motivated staff guarantees a consistent, high standard of production.



The number of products manufactured over the company's history reaches into the billions. State-of-the-art automation lines manufacture around the clock in a precise and high standard of quality. The efficient and low-cost production of large-scale product series is one of the strengths on which we have based our success.

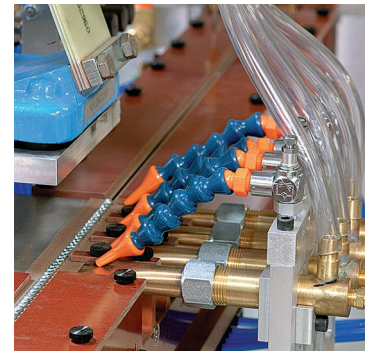

But our high-volume production output in no way compromises flexibility. We are able to quickly and efficiently produce even small batches of non-standard items.

Our well assorted inventory permits the reliable, prompt delivery of standard products, keeping your production running to schedule at all times and helping to minimize your warehousing costs.

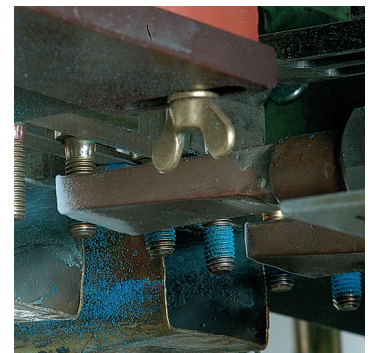

We are particularly proud of a cost-to-performance ratio which ensures satisfied customers the world over. This has made KerbKonus a reputable and respected partner to industry in the global marketplace.

Quality and environment are top priority issues at KerbKonus. Quality consciousness is a continuous thread running through every aspect of the company's work and all its products and services. Quality is lived and breathed at KerbKonus.

As manufacturer in the metal processing industry we are aware of our responsibility for an environmentally compatible production. With this in mind we follow up a policy of sensible resource spending and environmental-friendly production both in our process engineering and our product range..



Quality System
DEKRA Certificat in accordance with
ISO 9001:2015 Reg.No. 30507428
ISO 14001:2015 Reg.No. 170507049
ISO 50001:2011 Reg.No. 181115119

A secure connection for our customers ...

KerbKonus has enjoyed an excellent reputation as a surface treatment company over a period of many years.

Thread coating is something we view as a comprehensive service. Subject areas such as reliable delivery dates and flexibility mean more to KerbKonus than mere watchwords; they form the basis for maximum customer satisfaction.

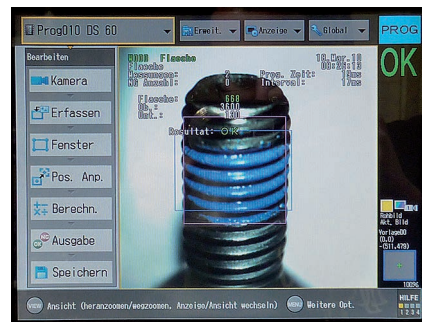

We carry out surface treatment at a number of locations (two of them in Germany), meaning that we are always within reaching distance for our customers. Short distances and production flexibility guarantee our customers the degree of delivery reliability they need to succeed.

Our flexibility is evidenced particularly by our ability to respond quickly to customer requests. We take charge of the entire logistical organization. And when the situation so requires, we act quickly and reliably to maintain the delivery capability of our customers – no matter how tight the bottleneck.

Our many years of experience as a supplier to the automotive industry have clearly highlighted the need for all-embracing solutions to connection problems which cut across conventional thematic boundaries.

With its know-how and its comprehensive range of products and services, KerbKonus is a truly dependable partner when it comes to „fastening technology you can rely on“.

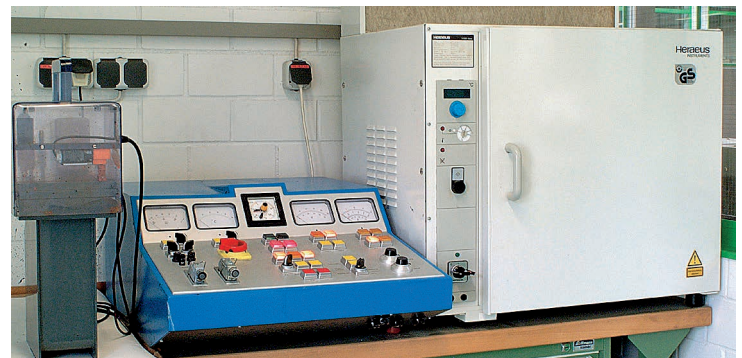

Coatings in application ...



Thread coating types Tuf-Lok®, Nytemp®, Nyseal®, Nyplas®, Nystay®, Top 300®, Nycote®, precote and 3M have been proven in practical application the world over.

KerbKonus offers a contract surface treatment service using these coating methods on supplied screws and nuts.



Product characteristics

- Security against working loose or unscrewing
- Provision of a fluid or gas-tight seal
- Use in materials of any optional strength or surface hardness
- No damage to surfaces as is possible with many washer elements or with toothed-head screws
- No notching effect under the head, eliminating the risk of permanent fractures in thin-walled mouldings
- No metering problems of the type encountered with fluid screw locking media
- No components becoming stuck on assembly belts



TufLok® – „der blaue Fleck“ (the blue patch) or as an allround coating

A reliable economic system for locking and sealing screw connections. A highly elastic, wear-resistant blue nylon coating is applied to part of the thread on screws and other threaded components.

Der TufLok®-spot creates a high frictional engagement during the installation process, firmly pressing together the flanks between the screw and nut thread.

At the same time, it fills the axial backlash between the screw and nut thread, creating a connection which prevents the screw from working loose under dynamic loads.

Nytemp®

High-temperature screw locking and sealing system for use at continuous temperature stress of up to 200°C (higher temperature stress also possible for short periods).

Due to the high coating temperature, this product can only be used on bright or phosphated threaded components. Short term corrosion protection may be applied subsequently.

Nyseal®

Nyseal® is a new concept, involving the application of elastic seals on screws and other threaded components prior to application, either directly under the head, flange or on the thread run-out. This eliminates the need for the use of manually applied washers, seals or O-rings.

Nystay®

Nystay® is a precoating made of plastic which is applied directly on the shank of the connecting elements to secure them during transport or installation in the relevant application or assembly.

Nyplas®

Nyplas® is a new concept which permits application of the sealing material plastisol/PVC directly under the head, flange or runout threads or screws or other threaded elements using a precoating technique. This eliminates the need for manually mounted washers, sealing rings etc.

Nycote®

Nycote® is a patent-protected coating method involving the application of insulating (non-conductive) Teflon powder on the heated threaded component.

Result: A protective layer which prevents unwanted deposits from primers, paints and other surfaces during the electrodeposition process.

precote Top 300®

precote Top 300® is a wax-based coating which provides a dry touch-proof gliding film. precote Top 300® is the ideal product wherever a lower coefficient of friction or reduced friction spread are required. It can also be used to reduce the installation resistance of self-tapping or trilobular screws.

precote/3M®

The principle goes by the name of microencapsulation: Minute fluid droplets trapped in a thin-walled capsule. This method allows fluid adhesive locking systems to be „packaged“ in powder form.

The powder-form microcapsules are worked into a reactive binder system and applied in this form to the thread surfaces. The threaded components are coated by mechanical droplet wetting using special coating plants.

During installation of the threaded components, the microcapsules break open, releasing the fluid adhesive locking medium, which dries quickly.

On the test stand ...



A company's success depends primarily on its productivity and innovative drive as well as on the quality of its services.

A high standard of quality is fundamental to any company's long-term success in the marketplace.

Quality improvement and enhanced productivity are not self-contradictory. Quite the contrary: Where an efficient, functioning Quality System is in place, they serve to complement each other.

For this reason, KerbKonus has invested heavily also in developing and expanding a system of internal production surveillance in its thread coating producing division.

Threaded inserts from KerbKonus are manufactured in large piece numbers. Human lives and safety can often depend upon these tiny components, for instance in the case of airbag retaining fasteners.

Because we bear this heavy responsibility, our products are tested and monitored in line with the most stringent directives. In the case of particularly critical applications, each and every part is exhaustively tested on state-of-the-art test equipment before it is delivered to you.



TufLok®/Nytemp® for self-locking external threads ...



TufLok® „der blaue Fleck“

(the blue patch) has proven highly successful in practical applications around the globe: In the automotive engineering industry, in heavy-duty machinery, fittings and appliance construction, in hydraulic systems, electrical and precision mechanics and in optical applications.

The TufLok®-spot is also suitable for use wherever other systems are unable to meet requirements for technical or economic reasons:

- For extremely small screws – from M 0,8
- For screws made of hard materials
- For screws whose cross-section must not be weakened
- For threaded bolts

Field of application

- TufLok®: Temperature resistant from -56° to +120°C. Following prior practical testing, applications up to +150°C are possible.
- Nytemp®: For high-temperature screw locking for continuous thermal stress of up to 200°C (higher thermal stress also possible for short periods).
- TufLok®: Does not dry out, shrink or decompose, has a practically unlimited storage life. Resistant to alcohol, oil, petrol and most thinners.

The TufLok®-coating is also suitable for use in the food industry.

Product features

- Excellent locking effect compared to other methods; even if screws are not correctly tightened.
- Vibration-resistant in every screw-in position. This makes the TufLok® screw ideally suited as an adjusting screw.
- Fluid and gas-tight seal. The nylon layer presses firmly into the flanks of the thread, so preventing the ingress of media. All-round coating is recommended for these applications.
- Replaces positive locking elements which are often forgotten and lost during assembly. The blue TufLok® dot is an integral part of the screw and cannot be lost.
- Multiple use. The highly elastic blue TufLok® spot always endeavours to regain its original shape. Its system typical spray edge area safeguards the contact surface from shearing off.
- No drying time whatsoever required – immediately capable of withstanding stress. No problems also when tightening the TufLok® screw during final installation.
- Suitable for all metallic materials, also for threaded components made of stainless steels, light alloys and brass, as well as for almost all surface-treated parts.

Installation

TufLok® screws are mounted either mechanically or manually using conventional tools. The TufLok® screw enhances productivity due to its capacity for fully automatic feed and installation. The female thread does not need to be free of oil or grease, so allowing torque levels to be decreased.

Coating

Coating takes place in accordance with works standard 900.1.

It is also possible for galvanized screws to be chromated after TufLok® coating; The concentration of nitric acid for activation of the zinc coat may not exceed five percent, it should always be kept as low as possible.

Optimum results are achieved with a clean, smooth and chip-free nut thread in the medium tolerance category. We generally recommend countersinking the female thread.

The TufLok® system can be used without problems in running production series without any need for tool modification.

Most special requirements relating to the position of the coating and the degree of torque can be accommodated.

Testing

Testing generally takes place in accordance with WS 900.1.

Other test methods must always be specified, and can include:

- DIN 267, part 28
- Customer test specimen with torque specification



**Thread coating with nylon
Clamping coating**
in accordance with DIN 267, Part 28

TufLok®/Nytemp®
Works Standard 900.1

Application

For the manufacture of ready-to-assemble, self-locking and sealing screws and threaded parts from M 0,8 to M 68.

Normal coating:

Coating angle α in the screw body area $\approx 90^\circ$, edge zone (spray transition) up to $\approx 180^\circ$. Coating length $B_1 \approx 4$ to 6 thread turns. Around 2 to 3 thread turns remain uncoated to ensure flawless installation (B_2).

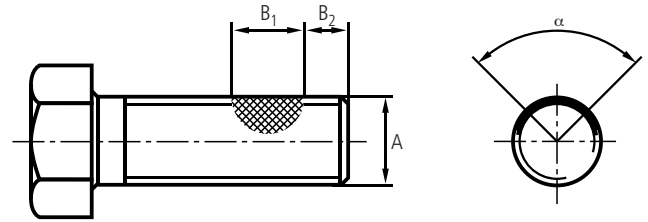

Torque levels according to Works Standard

Screws ISO 6g	I screwing in max. Nm	II First unscrewing min. Nm	III Fifth unscrewing min. Nm
M 2	0,2	0,04	0,02
M 3	0,45	0,1	0,05
M 3,5	0,7	0,2	0,1
M 4	0,9	0,28	0,17
M 5	1,6	0,4	0,23
M 6	3	0,8	0,4
M 8	6	1,5	0,8
M 10	9,5	2,3	1,2
M 12	13	3,4	1,7
M 14	19	4,5	2,3
M 16	28	7	3,5
M 18	36	9	4
M 20	44	11	5,5
M 22	60	15	7,5
M 24	80	20	10

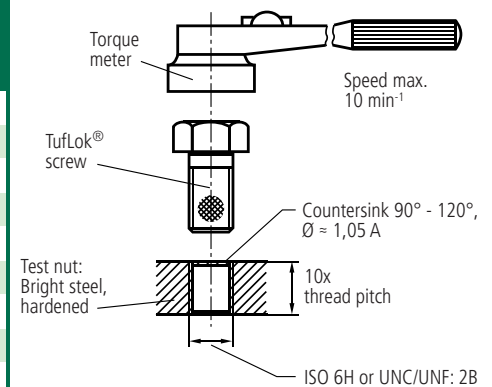

Torque testing

1. Torque testing should be carried out using properly calibrated gauges
2. Turn the screw into the test nut until the coating is positioned within the nut, measuring the maximum screw-in torque (max. values, see table, column I).
3. Back the screw out 90° , then measure the greatest torque during the following 360° (for target value, see table, column II).
4. Back the screw out completely from the test nut four times and then screw back in again. During the fifth unscrewing process, once again measure the greatest torque level during the first 360° (for target value, see table, column III).

The values specified in the table assume the use of screws whose material and surface quality are homogenous. Tightening torque levels during testing under pretension: see specifications of the screw manufacturer.

Special versions

Deviating coating lengths, spot or all-round coating and/or other coating positions. Deviating torque levels and values for different test methods (nut corresponding to DIN 267, part 28) or other screw dimensions respectively tolerances: Test coating required.

Alongside the standard colours blue for TufLok® and orange for Nytemp®, other colours can be supplied on request for purposes of differentiation (e.g. inch/metric, different strength classes and for identifying small dimensions, for example M1/M1,2).

Animation



TufLok®/Nytemp® for self locking internal threads ...



Self-locking internal threads are coated with a highly elastic nylon layer, TufLok® – „der blaue Fleck“ (the blue patch).

When screwing on the internal thread, this blue TufLok® spot brings about a high level of surface pressure against the flanks of the mating thread.

The nylon layer also fills out the axial backlash between the threads of the screw and nut, producing a vibration-proof connection which prevents the thread from working loose under dynamic stress, but can be released at any time.

Field of application

Self-locking TufLok® internal threads have proven highly successful throughout every branch of industry, for example in automotive engineering, and in all types of constructions and appliances – particularly where there is a danger of parts working loose from machines or vehicles in operation.

Product features

- The TufLok® internal thread coating brings about a high degree of locking safety.
- The self-locking TufLok® nut can be quickly and simply installed, either manually or using fully automatic screwing devices. It is ideal for precise setting work.
- In contrast to lock nuts with deformed threads or tothing, the TufLok® nut prevents any surface damage to the workpiece, thread erosion, as well as abrasion or damage to the screw thread.
- Additional locking elements can be dispensed with, meaning cost savings due to lower outlay for storage, scheduling and inventory management.
- The „built-in locking effect“ can never be left out accidentally during installation or be lost during repairs – meaning added security..
- The TufLok® internal thread is reusable.
- TufLok®: Temperature resistant from -56°C to +120°C. Following prior practical testing, applications up to +150°C are possible.
- Nytemp®: For higher continuous thermal stress of up to 200°C (higher stress levels possible for short periods).



**Thread coating with nylon
Clamping coating**
similarly DIN EN ISO 2320

TufLok®/Nytemp®
Works Standard 945

Application

For screw fastenings which are both vibration-resistant and capable of release at any time.

Standard coating

- patch coating
- 360° all round
- Coating to thread centre (spray transition at the thread start and end)

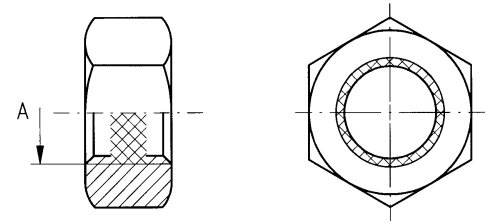

Torque values according to Works Standard

Dimensions in mm

Thread nut A	Clamping torque		
	First screwing on max.	First unscrewing min.	Fifth unscrewing min.
M 5	1,6	0,29	0,2
M 6	3	0,45	0,3
M 8	6	0,85	0,6
M 10	10,5	1,5	1
M 12	15,5	2,3	1,6
M 14	24	3,1	2,3
M 16	32	4,5	3

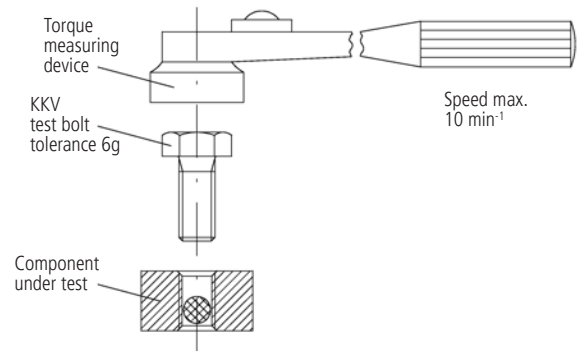

Suitable for all metallic materials, also for threaded parts made of stainless steel, light alloys and brass as well as for almost all surface-treated parts.

Torque testing

1. A KKV test bolt is used for testing.
2. Screw the KKV test bolt into the component under test until the coating is completely covered. The test bolt may project beyond the coating by no more than 1 – 2 turns. When turning, measure the maximum screw-in torque (see factory standard table).
3. Screw the test bolt back out by 90°, then during the following 360° measure the greatest screw-out torque (for target values, see the factory standard table).
4. Screw the bolt out of the component under test four times and screw back in. During the fifth screw-out process, measure the greatest torque again during the first 360° turn (target values in accordance with the factory standard table).

The values shown in the table require nuts which are homogenous in terms of material and surface quality. For the tightening torque during testing under pre-tension: see specifications of the nut manufacturer.

Thread

as per DIN 13

Resistance

See TufLok®-Works Standard 900.1

Locking

similarly DIN EN ISO 2320

Other dimensions and special coatings (torque levels) on request.

Special versions

Deviating coating lengths, spot or all-round coating and/or other coating positions. Deviating torque levels and values for different test methods (similarly DIN EN ISO 2320) or other nut tolerances: Test coating required.

Alongside the standard colours blue for TufLok® and orange for Nytemp®, other colours can be supplied on request for purposes of differentiation (e.g. inch/metric, different strength classes and for identifying).

Nyseal® – under-head pre-coating for sealing headed screws ...

Nyseal® is a new concept permitting elastic seals to be applied under the head, flange or at the thread run-out of screws or other threaded components – already prior to installation.

This eliminates the need to use manually mounted washers, seals or O-rings.

Field of application

Nyseal® is a green, optionally transparent plastic coating which is melted directly onto the underneath of the screw head. This achieves an excellent sealing effect against fluids and gases. At the same time, the coating acts as a buffer for sensitive surfaces of the workpieces to be joined.

Product features

- Low-cost pre-coating
- Prevention of corrosion under the screw head
- Excellent sealing properties
- No additional washers or seals needed
- Workplaces and assembly workstations are kept clean
- No waste





Nyseal® Sealing coat

Works Standard
903 2

Application

Melted directly onto the surface of a metal component, Nyseal forms a reusable seal, eliminating the need for costly hand mounted products.

Inserts for subsequently moulded plastic components can be coated, doing away with the need for costly O-rings.

On self-tapping or thread-tapping screws, the coating forms an additional sealing feature resistant to vibrations.

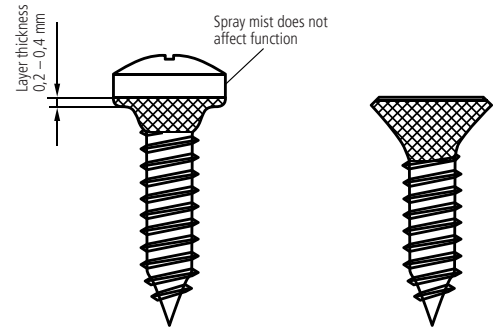

Example of aNyseal®-coating to WS 903 2

Dimensions in mm

Article number	Suitable for screws	Max. tightening torque ¹⁾ in Nm
903 200 030.000	M 3	0,6
903 200 040.000	M 4	1,4
903 200 050.000	M 5	2,6
903 200 060.000	M 6	4,5
903 200 080.000	M 8	11,0
903 200 100.000	M 10	22,0

¹⁾ Guideline values

On principle, before application of the Nyseal® coating, a practical test must be carried out using samples in order to check the tightening torques and also any possible reusability in the application.

Example for finding the article number

Nyseal®-coating in accordance with WS 903 2 on an M10 screw:
903 200 100.000

Product profile

Material: Polyolefin
 Operating temperature: 70°C
 Reusability: up to 10 mal, depending on load
 Shore hardness: 54
 Colour: green or transparent
 Maximum temperature: 90°C
 Sealing effect: up to 70 bar

Other dimensions and shapes, e.g. flange nuts, shaft screws and other connecting elements on request.

Storage stability

The applied Nyseal® coating is hygroscopic and should be stored under airtight and dry conditions at temperatures no higher than 27°C to ensure maximum shelf life.

Animation



Nystay® – the precoating intended to keep fasteners „in their place“ during transportation and assembly ...

Nystay® is a plastic precoating which is applied directly to the shank of fasteners in order to secure them during transportation or assembly in their relevant application/assembly group.

Field of application

Nystay® can be used for all fasteners – whether threaded or not. It facilitates preassembly, especially in case of automatic feeders and robot applications. The range of applications is, of course, not restricted to screws, but encompasses all fasteners such as shafts, rivets, studs, pressed and turned parts etc.

Product features:

- Holds fasteners in place during transport, assembly or installation
- Non-toxic and environmentally friendly – plastic coating on polyolefin basis
- No chemical hardening
- May be positioned at any optional location on the shank of a fastener
- Shortens assembly times for end user

User benefits:

Screws coated with Nystay® in the thread area can be pre-inserted into the component. The coating fixes the screw reliably in the borehole. The end user will therefore receive a subassembly already preassembled with screws, eliminating the need for tedious selection and insertion of appropriate screws. At the same time, fastener stocks can so be reduced and simplified. Operating and cycle times during final assembly can be drastically shortened when using pre-assembled components.





**Nystay®
Fixing coating**

Works Standard
903 4

Application

Nystay® is welded directly onto the fastener shank. This creates a flexible, annular layer providing reliable protection against loss for pre-assembled components during transportation or storage.

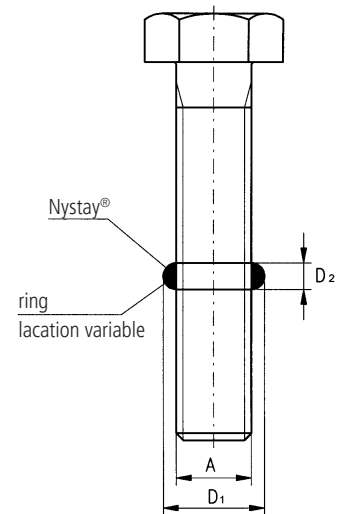

Dimensions in mm

Article number	Suitable for screws/bolts from		Ringdiameter (guideline value)	Ringdiameter (guideline value)
	A	A	D1	D2
903 400 030.000	M 3	Ø 3	3,3	3
903 400 040.000	M 4	Ø 4	4,4	4
903 400 050.000	M 5	Ø 5	5,5	4
903 400 060.000	M 6	Ø 6	6,6	4
903 400 080.000	M 8	Ø 8	8,8	5
903 400 100.000	M 10	Ø 10	11,0	5

Example for finding the article number

Nystay®-coating according to WS 903 4 on M10 screw:
903 400 100.000

Product profile

Material: Base material polyolefin
Operating temperature: -40° to +90°
Colour: green

Other dimensions and shapes, e.g. flange nuts, headless screws and other fasteners, on request.

Nystay® is a mere fixation coating/ protection against loss and cannot be examined by means of a functional metric (diameter). Practical tests need to be performed in advance. The coating diameters can be monitored reliably using examination sleeves of a minimum and a maximum diameter. Pressure points, blank parts and/or imperfect applications of the ring coating do not have any effect on the functionality and cannot be avoided.

Storage stability

The applied Nystay® coating is hygroscopic and should be stored under airtight and dry conditions at temperatures no higher than 27°C to ensure maximum shelf life.

Animation



Nyplas® – the coating which seals

Nyplas® is an innovative concept which allows Plastisol/PVC sealing material to be applied to screws and other thread elements directly underneath the head, flange or at the thread runout, using the precoating method.

The use of washers, sealing rings etc. to be applied manually is no longer required.

Field of application

Nyplas® is a black PVC/Plastisol coating which is applied directly to the underneath of the screw head. This ensures an excellent seal against liquids and gases. At the same time, this coating acts as a buffer for sensitive surfaces of the workpieces to be screw-fastened. Compared to our Nyseal® coatings, much higher layer thicknesses are achieved using Nyplas®. On principle, a practical test is recommended before use in production, in order to determine the required layer thicknesses.

Product features:

- Sealing/Soundproofing immediately after screw-fastening
- No need for O-rings, washers etc.
- Reusable
- Very good sealing properties
- Long life.
No shrinkage or drying out.
- Temperature application range:
-40°C to +150°C.

The following automotive specifications are met:

GM 6086M Type 3
GM 1131M Type D
Ford ESB-M4G70 A or B
Ford WSK-M4G70
Daimler Chrysler MSCD43





Nyplas®
Sealing coating

Works Standard
903 3

Application

Nyplas® is an innovative concept which allows Plastisol/PVC sealing material to be applied to screws and other thread elements directly underneath the head, flange or at the thread runout, using the precoating method.

The use of washers, sealing rings etc. to be applied manually is no longer required.

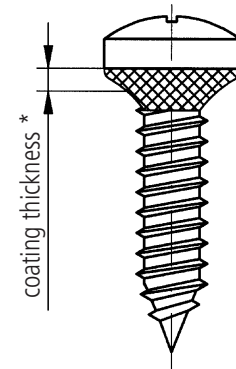

* Generally before starting of production would be recommended a practical attempt, to committed the necessary coating thickness

Article number	suitable for screws
903 300 030.000	M 3
903 300 040.000	M 4
903 300 050.000	M 5
903 300 060.000	M 6
903 300 080.000	M 8
903 300 100.000	M 10

Example for finding the article number

Nyplas®-coating according to WS 903 3 on an M10 screw:
903 300 100.000

Product profile

Material: Plastisol/PVC
Operating temperature: -40° to +150°C
Colour: black

Surface quality

The coating can be applied to all metal materials.
Threads should be free of oil and grease.
For bright phosphated parts, suitable corrosion preventives are permitted.

Storage stability

At least 3 years.
Nyplas® does not demonstrate any shrinkage or drying out over the storage period.

Application/Re-usability

On principle, a practical test is recommended before series application in order to check the function, compatibility and reusability of the coating in the application.
In combination with plastic surfaces (mating surfaces), in particular ABS, acrylic or polycarbonate, the Nyplas coating should not be used. Nyplas is made of plastisol and can impair the material characteristics of plastics in unfavourable circumstances.
Possible reusability is also highly dependent on the mating surface and tightening parameters (friction should always be as low as possible in the system) and must be tested in advance without fail using samples.

Animation



Nycote® – the insulating coating ...

Where thick deposits impair the easy running properties of screws, Nycote® offers the ideal protection: from cathodic primers and paints applied during electrodeposition, particularly when using the cathodic principle.

The solution: Nycote®

Exhaustive testing has shown that Nycote® has characteristics which prevent cathodic primers or paints from adhering to threads.

Wherever the Nycote®-protective layer covers the thread, it is not possible for primers or paints to adhere to the surface.

Threaded components – both internal and external threads – are pre-coated using a special technique. They then go on to be processed in the accustomed way without problems on the production line, for example using welding machines.

Another benefit: This processing method also prevents the often troublesome adhesion of welding beads.

Fields of application

Wherever electrodeposition are used and threaded areas have to be covered over, it makes sense to use parts pre-coated with Nycote®.

When using this method, the application of Nycote® on the coupling elements serves to cover the required threaded area: This effectively prevents paint deposits on the threads which would impair installation.

Another benefit of Nycote®: Improved screw sliding properties. Nycote® reduces the coefficient of friction during installation and guarantees a defined clamping force.

The process is ideally suited for the fast installation processes demanded by many branches of industry today.

Nycote® replaces the coats of wax or lubricant which are often applied to improve sliding properties.



Benefits of applying an insulating coat ...



How the Nycote®-coating works

Nycote® is a patent-protected coating method involving the application of insulating (non-conductive) Teflon powder on a heated threaded component. This forms a protective layer against unwanted deposits of primers, paints and other surfaces during electrodeposition.

The Nycote® thread coating is the lowcost alternative to most customary coverings. It generates a certain lubrication effect at the threads, reduces unwanted noises created during installation and prevents welding splashes from adhering to the surface.

When installing the threaded component, the Nycote® layer is rubbed off the supporting thread flanks, creating bright, metallic contact surfaces for outstanding electrical conductivity and defined screw connection strength.

The abraded material is pressed into the cavities of the thread coupling, particularly in the root area of the nut thread and at the crest of the screw thread.

Due to a chemical process, Nycote® does not adhere to the thread surfaces of the fastening element.

During coating, the Teflon powder is melted into the pores and cracks in the surface, so creating a mechanical bond: Strong enough to hold the coating on the surface of the threaded element and weak enough to guarantee its abrasion during the installation process.

The benefits at a glance

- Nycote® reduces the coefficient of friction, so allowing weld nuts and bolts to be more quickly installed and eliminating the need for subsequent oiling or greasing.
- The special sliding properties of Nycote® reduce the „chattering“ noise produced by the screwing process, thus preventing the unpleasant high frequencies created when screwing metal on metal.
- Nycote® is made of Teflon, and is therefore completely harmless both to health and to the environment.
- Nycote® protects against unwanted deposits during electrodeposition, priming and coating, see animation 1.
- Nycote® prevents paint deposits during painting operations. During subsequent installation of the threaded components, the coating is designed to rub off and so ensure a conductive screw connection, see animation 2.
- Nycote® reduces variance in the coefficient of friction, in order to maintain the correct pretension force during installation.
- Nycote® prevents the often troublesome adhesion of welding beads during the welding process both on the surface of welded bolts and also in the internal thread of welded nuts. Laborious and costly reworking operations are no longer required, see animation 3.

Application in the automotive engineering industry

All car manufacturers offer long warranty periods today as a purchase incentive. Good corrosion resistance is of instrumental importance here, which the automotive industry has addressed by developing new primers and paints.

These new primers present a number of problems. During electrodeposition, the pre-assembled body in white with all the necessary fastening elements passes through an immersion tank containing the primer, which adheres to each component by means of a cathaphoretic process, including the fastening elements of any existing threads.

This coating is difficult to remove, and this process often involves costly reworking. However, clean threads are essential to correct and troublefree assembly.

The following automotive specifications are met:

- VW TL 188
- GM 6076 M
- Ford WSS-M21P27-A3
- Mercedes Benz MBN 10392
- Fiat 9.57455

Animation 1



Animation 2



Animation 3



... saves rework and costs

Coating with Nycote®-reduces variance in the coefficient of friction, achieving a defined degree of pretension.



Variance in the coefficient of friction today plays a co-determining role in the dimensioning of a screw connection in all currently used methods of screw tightening.

As in most cases a torque-controlled method of screw connection tightening is used, the required pretension force F_V determined by the tightening torque M_A .

This means that the pretension force F_V cannot be measured directly. It is calculated indirectly as a function of the tightening torque.

To simplify, a minimum pretension force $F_{V \min}$ is required to ensure the reliable function of a screw connection. This $F_{V \min}$ must be achieved even under adverse installation conditions, i.e. at maximum thread friction levels.

The diagrams indicate that with the same tightening torque but reduced coefficient of friction, the achieved pretension force F_V rises. This can lead to excess stress and failure of the screw connection.

Due to the relatively large variance in the coefficients of friction occurring with uncoated surfaces, it was formerly frequently necessary to resort to overdimensioned screw connections.

The use of Nycote® prevents variance in the coefficient of friction and so reduces the need for overdimensioning. The result: benefits in terms of both weight and costs. At the same time, the use of Nycote® reduces the coefficient of friction in the thread.

Diagram (1) illustrates the results of a comparative test of ten screws coated with Nycote® and ten identical screws, oiled, with a bright steel finish.

With a tightening torque of $M_A=20$, the Nycote®-coated screws demonstrate a variance in the pre-tension force F_V of 1.5 kN (bandwidth of the blue diagram at a torque of 20 Nm). In the case of the uncoated screws, a variance of 11 kN results – in other words a value almost eight times higher.

The same test, performed using corresponding nuts - diagram (2) - indicates a variance in pretension force of only 2.6 kN at a tightening torque of $M_A=22$ Nm, while the bright nuts demonstrate a variance of 10.4 kN.

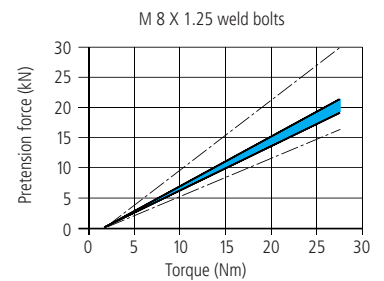

Diagram (1)

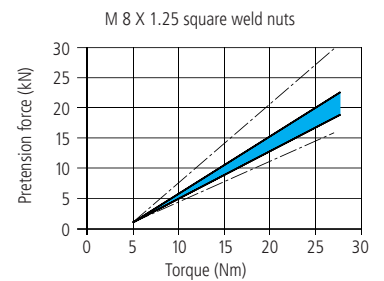
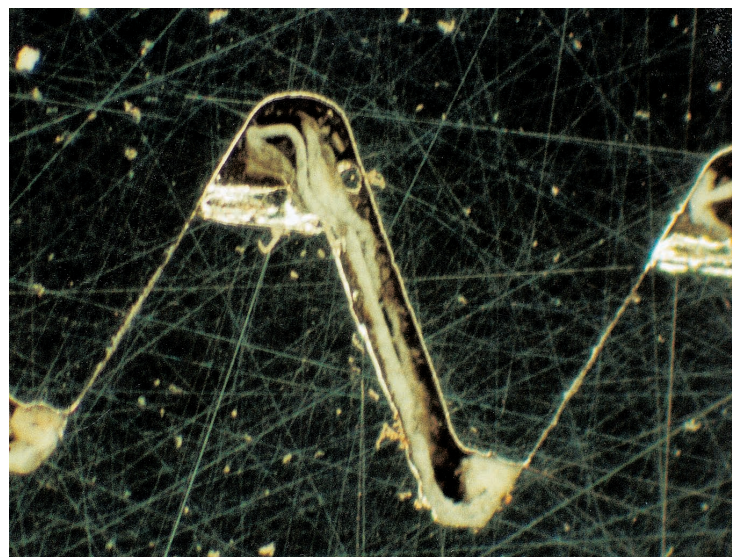

Diagram (2)





Nycote®
Insulating plastic coating

Nycote®
Works Standard
911/912/913

Application

For protection against cathodically applied electrodeposition coatings (cataphoretic primers and paints) using the KTL technique. This involves high layer thicknesses which can impair the easy running properties of threads.

At the same time, coating with Nycote® exerts a favourable influence on the coefficient of friction occurring in threaded components and prevents the frequently occurring adhesion of weld splashes.

Using Nycote®, previously essential cover-up or reworking operations are now eliminated.

Coating of bolt thread WN 911/912:

The head remains free of coating.

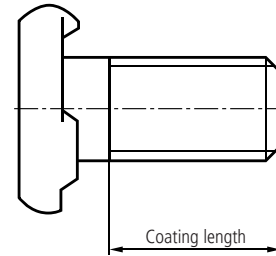

Coating of nut thread WN 913:

The thread chamfer remains free of coating to ensure troublefree welding.

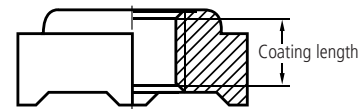

Spray transitions at the start and end of the coating do not affect the function.

Tests

1. Prior to coating, the easy running properties of the nut or bolt are tested using a 6H gauge plug or a 6g gauge ring by means of random testing.
2. During the coating process, a test of the easy-running properties is performed using KKV test bolts / KKV test nuts at defined intervals and in defined piece numbers. KKV test bolts / nuts mean that the core diameter has been produced to mean tolerance.
3. Final testing is performed using a standard commercially available true-to-gauge screw or nut.
4. In addition, parts can be cathodically immersion painted in order to test that no paint adheres to the coated nut or to the bolt.

A surface treatment of parts prior to Nycote® coating is not necessary. The parts should be delivered in a bright/oiled condition. After coating they are returned in a bright condition or with a short-term corrosion protection (oil).

Nycote® can be applied to galvanized surfaces. The necessary heating process of the threaded parts to the melting temperature of the powder brings about an optical and functional impairment of the surface. The corrosion protection effect of the galvanized layer may be compromised under certain circumstances. Consequently the user should clarify all details before placing an order.

The coating itself has an unlimited shelf life. However, the corrosion resistance (effect of the corrosion protection agent) should be borne in mind for the complete part. Mechanical stress of the coating, in particular during handling, results in spot damage to the closed layers, in particular in the case of bolt threads. There can be localized accumulations of paint in these areas during electrical immersion painting. However, this does not result in any functional impairment.

The coating must be present on the contact surfaces of the thread flanks. In terms of functionality, a full coating on the thread tips or on the thread base is not necessary and, thus, defects in this area are admissible.

Nycote® is not wear-resistant and, due to the handling in the further process chain, may rub off, in particular on the thread tips. Nycote® is generally suitable for resistance welding (projection welding). Due to higher temperature (>300°C), other procedures are to be tested and confirmed by means of trials before.

precote 30/80/85 • 3M 2353/2510 locking coat for external and internal threads ...



Field of application:

A variety of standard products are offered to address different practical requirements.

precote 30:

For thread sealing and medium strength thread locking. Easy dismantling, no subsequent hardening.

precote 80:

Universal screw locking system, high-strength, temperature resistant to 170°C; Also suitable for sealing applications.

precote 85:

Universal screw locking system, high-strength, with slow thread friction value, temperature resistant to 170°C; Also suitable for sealing applications

precote Varianten:

-3 for faster curing

(e.g. precote 80-3)

-8 for smaller thread dimensions

(e.g. precote 80-8)

3M:

Gluing and sealing function, insensitive to oil and grease, reliable, self-locking effect in response to vibration forces transversely to the screw axis.

Product features

- Extremely good thread locking action against dynamic stress and absolutely reliable seal.
- High temperature resistance from -50°C to +170°C (with precote 80).
- The nut and locking element are inseparably joined, meaning that the locking element can never get lost or be forgotten.
- Replaces conventional and in some cases unreliable mechanical locking elements such as circlips, castellated nuts, plain washers, wire locking elements, locking plates etc.
- Good resistance to chemicals such as fuels, hydraulic oils, coolants etc., corrosion-inhibiting.
- Corrosion inhibiting.
- Economical due to large-series coating and use of customary installation tools.
- Saves costs for inventory management, storage and assembly of locking materials.

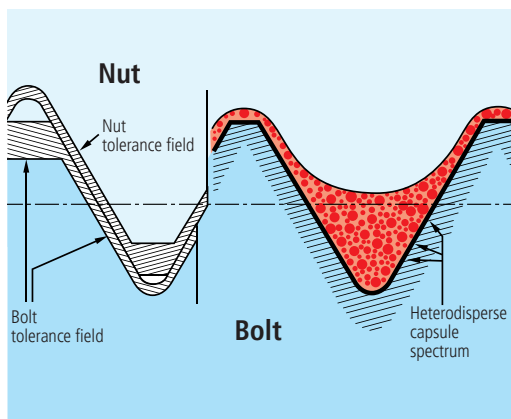



External and internal thread coating with plastic adhesive (microcapsules)
adhesive coating in line with DIN 267, part 27

precote 30/80/85
3M 2353/2510
Works Standard 924 to 929

Application

For the manufacture of ready-toinstall self-locking screws and threaded components from M2.

Standard coating external

$B1 \approx A$, 360° all round.
Around 2 to 3 thread turns remain uncoated to ease the screwing action ($B2$).

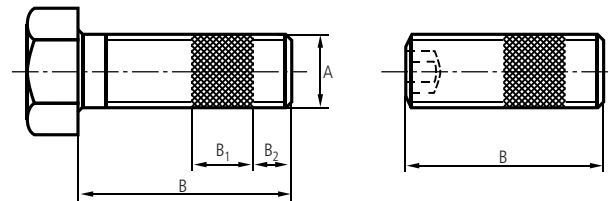

Standard coating internal

360° all round.
Begin of coating, each 1st respectively last thread turn.

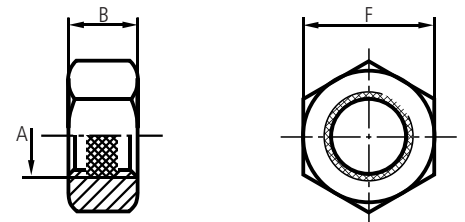

	precote 30	precote 80	precote 85	3M 2353	3M 2510
Article no.					
– Nuts, internal thread	924 ... 300	924 ... 800	924 ... 900	925 ... 000	925 ... 900
– Headed screws	926 ... 300	926 ... 800	926 ... 900	928 ... 000	928 ... 900
– Studs	927 ... 300	927 ... 800	927 ... 900	929 ... 000	929 ... 900
Coating colour	yellow	red	turquoise	blue	orange
Breakaway torque:					
Installed under pretension	mid-range	$\geq 0,9 M_A$	$\geq 0,9 M_A$	$\geq 0,9 M_A$	$\geq 0,9 M_A$
Not installed under pretension		min. 10 Nm	min. 10 Nm	min. 10 Nm	min. 10 Nm
Temperature range	-50°C to +150°C	-50°C to +170°C	-50°C to +170°C	-30°C to +110°C	-30°C to +150°C
Coefficient of thread friction μ (Guideline values)	0,10 to 0,15	> 0,25	0,10 to 0,15	0,18 to 0,22	0,20 to 0,25
Hardening time (room temperature)	24h	24h	24h	24h	72h

M_A = tightening torque

All values refer to M10 black tempered screws (thread pairing medium tolerance range), coating length $\approx A$, 360° all round.

Surface properties

The coating can be applied to all metal thread materials. **The thread should be free of oil and grease.** When using bright, phosphatized parts, suitable corrosion protection agents are admissible. In the case of coefficient of friction-reduced surfaces, a reduction of the M_{LB} can occur.

Hardening properties

Curing begins shortly after screwing in the thread. Adjustment and tightening processes should therefore have been completed within 5 minutes. Sufficient functional strength is generally achieved after around 30 minutes; curing is faster with precote -3. For smaller thread dimensions, use precote -8. Precote also cures at temperatures as low as -20°C, but with a lower curing speed

Storage life

of coated screws: 3 years at room temperature. precote 30 and precote 80 still offer particularly good storage properties under humid conditions.

Reusability

Screws with coating 3M 2353 and 3M 2510 can be used several times provided the framework conditions (thread free of oil and grease) are adhered to. However, as undefinable conditions can occur, we do not advise the reuse of threaded parts which have broken loose.

Further technical details should be clarified depending on the case in question.

Animation



precote 5/15 sealing coat for external and internal threads ...



Field of application

These sealing agents, which are composed largely of mineral filling agents and lubricants on a dispersion basis, are used for precoating processes in many applications in the automotive, appliance and mechanical engineering industries for sealing screw unions.

The coatings, which are dried after application, react neither with the coated thread nor the mating thread: This makes later releasing and retightening of the screw joint unproblematical. Furthermore, the base material of the thread is not restricted to metallic materials.

The dried surface is stable and nonsticky, meaning that longer storage periods at room temperature prior to final use for installation are possible without the need for any additional precautions.

The good resistance level of the layers to a large number of gases, aqueous and non-aqueous fluids as well as high pressure levels also at temperatures up to +180°C results in an extremely wide range of application for users of this type of pre-coated threaded component.

Product features

- Maximum sealing action against gases and most aqueous and nonaqueous fluids.
- Depending on the material and configuration of the thread coupling, connections offer a reliable seal even up to pressure levels as high as 50 bar.
- The threaded component and sealing element are inseparably connected, excluding the possibility of costly secondary installation operations due to forgotten or lost seals.
- Economical due to large-series coating and capacity for the use of automatic installation equipment.
- Saves on inventory management, storage and installation of additional sealing elements.
- precote 15: certified according to DIN DVGW





External and internal thread coating with dispersion layer Thread seal

precote 5/15
Works Standard
924/926/927

Application

For the manufacture of ready-toinstall, sealing screws and threaded components from M2.

Standard coating external

$B1 \approx A$, 360° all round.
Around 2 to 3 thread turns remain uncoated to ease the screwing action (B2).

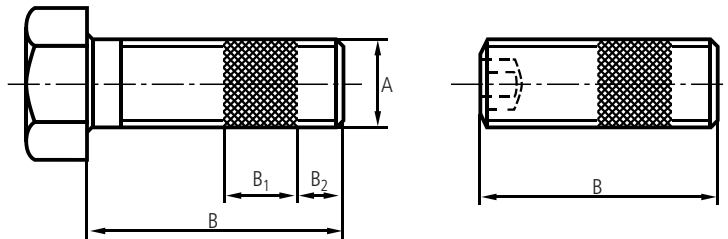

Standard coating internal

360° all round.
Begin of coating, each 1st respectively last thread turn.

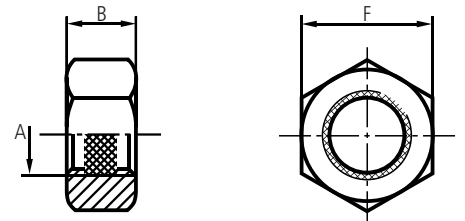

	precote 5	precote 15
Article no.		
– Headed screws	924 500	924 1.. ... 500
– Studs	926 500	926 1.. ... 500
– Stud screws	927 500	927 1.. ... 500
Coating colour	white	white
Temperature range	-60°C to +160°C	-60°C to +180°C
Storage life / RT	at least 3 years	at least 3 years

Applications

The sealants can be applied to all metal and non-metal threaded components such as screws, studs, set screws, fittings etc. both in cylindrical/cylindrical and also cylindrical/conical couplings from thread diameter 4 mm.

Characteristics

Sealing action against gases, aqueous and non-aqueous fluids under high pressure levels and temperatures up to max. +180°C

Preliminary treatments

If the coated threads are to be used more than once, the surfaces must be dry, free of dirt, oil, separating agents and other contamination prior to coating.

Animation



precote Top 300® • OKS 1765 – precoating for outstanding lubrication capability

precote Top 300® is a new type of synthetic wax based precoating which produces a touch-proof, dry lubricant film.

Field of application

Partial precoating with precote Top 300® offers an ideal solution wherever low thread torque coefficients or reduced friction spread are required. It can also be used to reduce the installation resistance of self-tapping or trilobular screws.

precote Top 300® can be applied to all threaded elements, and produces a dry yellowish lubricant film.

It effectively prevents cold welding when working with problematical material combinations, and also prevents fastening problems – particularly with VA screws. precote Top 300® permits controlled installation of screw fastenings.

The coating can also be partially applied under the screw head, permitting combination with screw locking coatings in the thread while ensuring adherence to prescribed coefficient of friction windows, for example in screw fasteners used in the automotive industry.

Product features:

- Ideal way of reducing installation torque on self-tapping or trilobular screws
- Non-toxic, assembly friendly
- Cost-effective by saving total installation costs
- Prevents „chattering“ and „galling“ during the installation of screw fasteners
- Captive „precoating“ ready for use on the threaded element
- Male and female threads can be coated

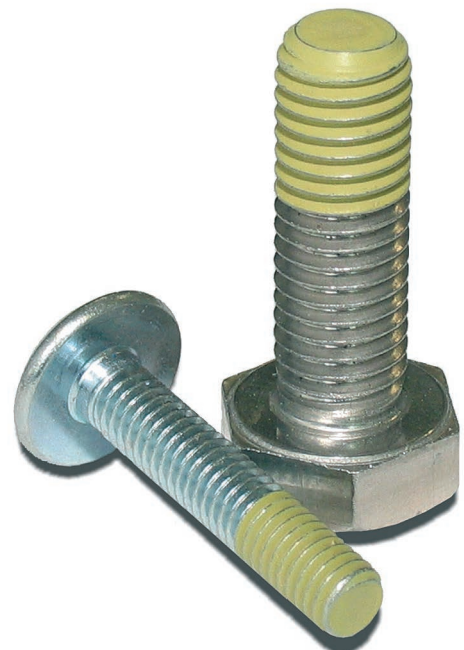



Coating
synthetic wax-based

precote Top 300®
OKS 1765
Works Standard 930

Application

Coating of a dry, tack-free lubricant film on thread surfaces.

Standard coating on male thread

All round 360°
On placement of order, please state coating length.

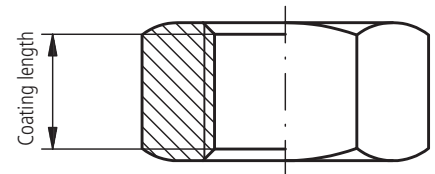
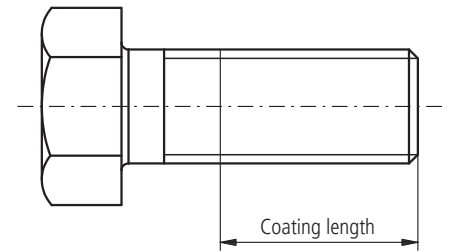

Article number			Suitable for Screws
Top 300® yellowish	OKS 1765 yellowish	OKS 1765 transparent	
930 300 030.000	930 400 030.000	930 700 030.000	M 3
930 300 040.000	930 400 040.000	930 700 040.000	M 4
930 300 050.000	930 400 050.000	930 700 050.000	M 5
930 300 060.000	930 400 060.000	930 700 060.000	M 6
930 300 080.000	930 400 080.000	930 700 080.000	M 8
930 300 100.000	930 400 100.000	930 700 100.000	M 10

Other dimensions on request

Example for finding the article number:

precote Top 300®-coating according to WS 930 on an M10 screw:
930 300 100.000

Material:

Synthetic wax

Colour:

yellowish, transparent

precote 709 – The anti-seize thread precoat

precote 709

is a nonreactive, film-forming dispersion with mineral solid lubricants for coating threaded parts, enabling controlled assembly and disassembly for high-temperature applications.

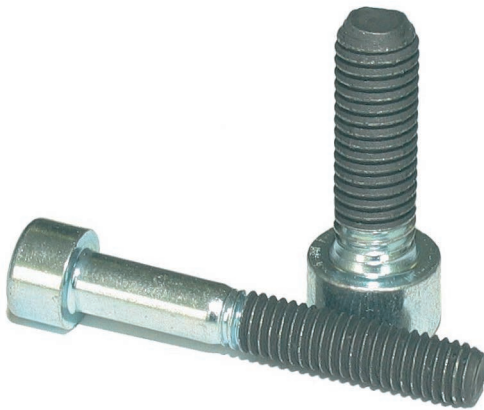

Field of application

For use on threaded parts like screws and studs, plugs and pipe threads which require a high preload on assembly without surface welding but after exposure to high temperature permit an easy and non-destructive disassembly.

Product features

- Dry, tack-free film
- Physiologically harmless during processing and after coating
- Low-cost precoat
- Constant low coefficient of friction
- No galling or cold welding
- Prevents corrosion in the threaded connection
- Separation effect up to +850°C
- Good chemical resistance

Material:	Dispersion with mineral solid lubricants				
Colour:	anthracite				
Operating temperature:	up to +850°C				
Thread coefficient of friction:	0,09 – 0,13				
Installation torque:	at M10 1 – 2 Nm				
Shelf life:	4 years at room temperature				
Coating type	<table> <tr> <td>Partial screw</td> <td>Article number 926... ..400</td> </tr> <tr> <td>Partial stud</td> <td>Article number 927... ..400</td> </tr> </table>	Partial screw	Article number 926... ..400	Partial stud	Article number 927... ..400
Partial screw	Article number 926... ..400				
Partial stud	Article number 927... ..400				

precote 10-1 – Prevail torque precoating

precote 10-1

Is a non-reactive, film-forming polyamide dispersion for coating threaded parts. It is a physiologically harmless precoating for immediate locking and sealing of cylindrical and conical threads. The dried film is tack-free and dry to the touch.



Field of application

On threaded parts both in cylindrical/cylindrical and cylindrical/conical combinations of screws and studs or plugs for locking and fixing as well as sealing against splash water or other fluids. The special formulation eliminates the need to melt the coating. Repeated use is possible.

Product features

- Forms touch-proof film
- Absolutely tack-free coating
- Fixes, locks and seals immediately on assembly
- Reusable
- Physiologically harmless, both during processing and in coated condition
- Threaded parts can be coated in advance
- Prevents corrosion in the threaded connection
- Can be applied on all threaded metal materials
- Excellent chemical resistance

Material:	Non-reactive polyamide dispersion	
Colour:	green	
Operating temperature:	up to 100° C (water) / to 150° C (oil) / RT for fuel and diesel	
Torque levels:	can only be determined after practical testing	
Shelf life:	Unlimited at room temperature	
Coating type	Screw all round	Article number 924... ..100
	Stud all round	Article number 926... ..100
	Internal thread	Article number 927... ..100

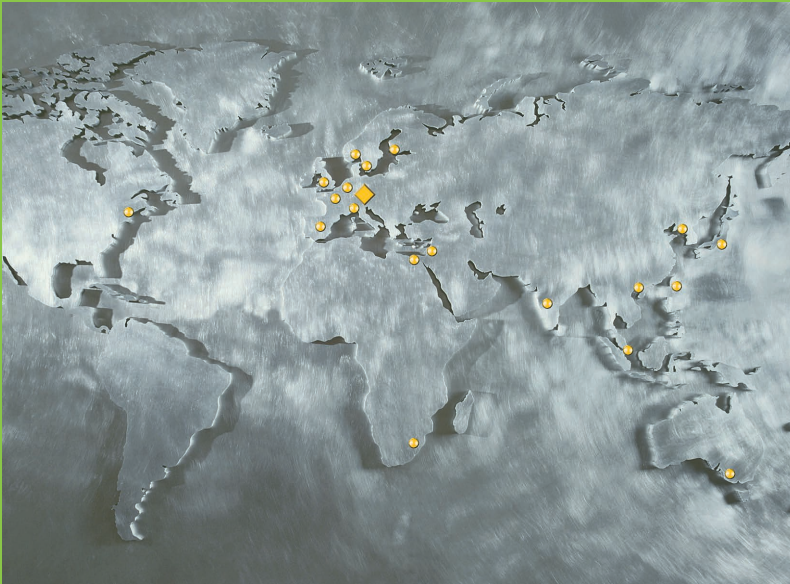

KerbKonus - Close to its customers. Around the world. Across every sector of industry.

First and foremost, for you customer proximity means a rapid response to your requirements and the fast, efficient realization of the right fastening solution for you.

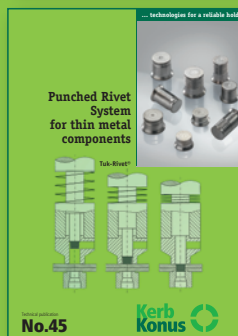
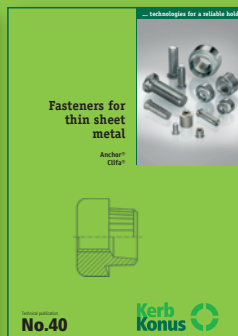

Kerb-Konus-Vertriebs-GmbH
P.O. Box 1633
92206 Amberg

Phone +49 9621 679-0
Fax +49 9621 679444
e-mail KKV-Amberg@kerbkonus.de

Internet www.kerbkonus.de

... in Germany

Amberg Headquarters **Production and Sales**
Hadamar

Kerb-Konus-Vertriebs-GmbH
Werner-von-Braun-Straße 7
92224 Amberg

... and around the world.

Kerb-Konus
Fasteners Pvt. Ltd.
Kolhapur/India

Kerb-Konus UK
Rugeley/Staffordshire
UK

K.K.V. Corporation Japan
Osaka/Japan

Kerb Konus Espanola S. A.
Navalcarnero/Madrid
Spain

KKV AG
Zug/Switzerland

KKV Belgium
Aalst/Belgium

Precision Fasteners Inc.
Somerset, New Jersey/USA

Sofrafix
Bethune
France

Kerb-Konus Italia s.r.l.
Mulazzano (LO)/Italy

Other foreign agents in a wide number of countries.
Addresses on request or under www.kerbkonus.com

